



# EMC TEST REPORT

**Reference No.**..... : WTU15U0933879E  
**Applicant**..... : Wuxi Sans Electronic Co.,Ltd.  
**Address**..... : Industrial WuYi,DongGang Town,Wuxi City,Jiangsu Province,China  
**Manufacturer** ..... : Wuxi Sans Electronic Co.,Ltd.  
**Address**..... : Industrial WuYi,DongGang Town,Wuxi City,Jiangsu Province,China  
**Product Name**..... : Li-ion Battery Charger  
**Model No.**..... : SSLC076V42BD  
**Standards**..... : EN 55014-1: 2011  
                           : EN 55014-2:1997+A1:2001+A2:2008  
                           : EN 61000-3-2:2014  
                           : EN 61000-3-3:2013  
**Date of Receipt sample** .... : September 16, 2015  
**Date of Test** ..... : September 17, 2015~October 15, 2015  
**Date of Issue**..... : October 16, 2015  
**Test Report Form No.**..... : EN 55014-2A  
**Test Result**..... : **Pass \***

Remarks:

\*The results shown in this test report refer only to the sample(s) tested, this test report cannot be reproduced, except in full, without prior written permission of the company.  
 The report would be invalid without specific stamp of test institute and the signatures of compiler and approver.

**Prepared By:**

**Waltek Services (Suzhou) Co., Ltd.**

No.699 Lushan Road,SND.Suzhou,Jiangsu China.

Tel :+86-512-66032998

Fax:+86-512-66032668

Compiled by:

Mathea.Zhang

Reviewed by:

Fish.Yu



Approved by:

Jackie.Zhang



## 1 Test Summary

EMISSION				
Test Item	Test Standard	Class / Severity	Result	
Mains Terminal Disturbance Voltage, 148.5kHz to 30MHz	EN 55014 -1: 2011	Clause 4.1.1	Pass	
Disturbance Power, 30MHz to 300MHz	EN 55014 -1: 2011	Clause 4.1.2	Pass	
Discontinuous Disturbance (Click)	EN 55014 -1: 2011	Clause 4.2.2	Pass	
Radiated Emission, 30MHz to 1000MHz	EN 55014 -1: 2011	Clause 4.1.2	N/A	
Harmonic Current emission	EN 61000-3-2:2014	Class A	Pass	
Voltage Fluctuation and Flicker	EN61000-3-3:2013	Clause 5	Pass	
IMMUNITY ( EN 55014 -2:1997+A1:2001+A2:2008 )				
Test Item	Test Method	Class / Severity	Performance Criteria	Result
Electrostatic Discharge(ESD)	IEC 61000-4-2:2008	±4 kV Contact ±8 kV Air	B	Pass
Radio-frequency electromagnetic fields (80MHz to 1GHz)	IEC 61000-4-3:2010	3V/m, 80%, 1kHz, Amp. Mod.	A	Pass
Electrical Fast Transients (EFT)	IEC 61000-4-4:2012	AC ±1.0kV DC ±0.5kV	B	Pass
Surge	IEC 61000-4-5:2014	±1kV D.M.† ±2kV C.M.‡	B	Pass
Injected Currents, 0.15MHz to 230MHz	IEC 61000-4-6:2013	3Vr.m.s.(emf), 80%, 1kHz Amp. Mod.	A	Pass
Voltage Dips and Interruptions	IEC 61000-4-11:2004	0 % UT* for 0.5per	C	Pass
		40 % UT* for 10per		Pass
		70 % UT* for 25per		Pass

Remark:

Pass	Test item meets the requirement
Fail	Test item does not meet the requirement
N/A	Test case does not apply to the test object
A.M	Amplitude Modulation
†	Differential Mode
‡	Common Mode
*	U <sub>T</sub> is the nominal supply voltage





## 2 Contents

	Page
<b>COVER PAGE</b> .....	<b>1</b>
<b>1 TEST SUMMARY</b> .....	<b>2</b>
<b>2 CONTENTS</b> .....	<b>3</b>
<b>3 GENERAL INFORMATION</b> .....	<b>5</b>
3.1 GENERAL DESCRIPTION OF E.U.T. ....	5
3.2 DETAILS OF E.U.T. ....	5
3.3 DESCRIPTION OF SUPPORT UNITS .....	5
3.4 STANDARDS APPLICABLE FOR TESTING .....	5
3.5 TEST FACILITY .....	6
3.6 SUBCONTRACTED .....	6
3.7 ABNORMALITIES FROM STANDARD CONDITIONS .....	6
<b>4 EQUIPMENT USED DURING TEST</b> .....	<b>7</b>
4.1 MEASUREMENT UNCERTAINTY .....	9
<b>5 EMISSION TEST RESULTS</b> .....	<b>10</b>
5.1 MAINS TERMINALS DISTURBANCE VOLTAGE, 148.5kHz TO 30MHz .....	10
5.1.1 E.U.T. Operation .....	10
5.1.2 Block Diagram of Test Setup .....	10
5.1.3 Measurement Data .....	11
5.1.4 Mains Terminals Disturbance Voltage Test Data .....	11
5.2 DISTURBANCE POWER, 30MHz TO 300MHz .....	13
5.2.1 E.U.T. Operation .....	13
5.2.2 Block Diagram of Test Setup .....	13
5.2.3 Measurement Data .....	14
5.2.4 Disturbance Power Test Results on AC Line .....	14
5.3 HARMONICS CURRENT EMISSION .....	15
5.3.1 E.U.T. Operation .....	15
5.3.2 Block Diagram of Setup .....	15
5.3.3 Harmonic Current Emission Test Data .....	16
5.4 VOLTAGE FLUCTUATION AND FLICKER .....	24
5.4.1 E.U.T. Operation .....	24
5.4.2 Block Diagram of Setup .....	24
5.4.3 Voltage Fluctuation and Flicker Test Data .....	25
<b>6 IMMUNITY TEST RESULTS</b> .....	<b>26</b>
6.1 PERFORMANCE CRITERIA .....	26
6.2 ELECTROSTATIC DISCHARGE (ESD) .....	26
6.2.1 E.U.T. Operation .....	27
6.2.2 Block Diagram of Setup .....	27
6.2.3 Direct Discharge Test Results .....	28
6.2.4 Indirect Discharge Test Results .....	28
6.3 ELECTRICAL FAST TRANSIENTS (EFT) .....	28
6.3.1 E.U.T. Operation .....	29
6.3.2 Block Diagram of Setup .....	29
6.3.3 Test Results .....	29
6.4 SURGE .....	30
6.4.1 E.U.T. Operation .....	30
6.4.2 Block Diagram of Setup .....	30
6.4.3 Test Results .....	31
6.5 RADIO-FREQUENCY ELECTROMAGNETIC FIELDS, 80MHz TO 1GHz .....	31
6.5.1 E.U.T. Operation .....	31



6.5.2	<i>Block Diagram of Setup</i> .....	32
6.5.3	<i>Test Results</i> .....	32
6.6	INJECTED CURRENTS IMMUNITY, 0.15MHZ TO 230MHZ .....	33
6.6.1	<i>E.U.T. Operation</i> .....	33
6.6.2	<i>Block Diagram of Setup</i> .....	33
6.6.3	<i>Test Results</i> .....	34
6.7	VOLTAGE DIPS AND INTERRUPTIONS .....	35
6.7.1	<i>E.U.T. Operation</i> .....	35
6.7.2	<i>Block Diagram of Setup</i> .....	35
6.7.3	<i>Test Results</i> .....	36
<b>7</b>	<b>PHOTOGRAPHS – TEST SETUP</b> .....	<b>37</b>
7.1	PHOTOGRAPH – MAINS TERMINAL DISTURBANCE VOLTAGE TEST SETUP .....	37
7.2	PHOTOGRAPH – DISTURBANCE POWER TEST SETUP .....	37
7.3	PHOTOGRAPH – HARMONIC CURRENT AND VOLTAGE FLUCTUATION AND FLICKER TEST SETUP .....	38
7.4	PHOTOGRAPH – ESD IMMUNITY TEST SETUP .....	38
7.5	PHOTOGRAPH – EFT IMMUNITY TEST SETUP .....	39
7.6	PHOTOGRAPH – RADIO- FREQUENCY ELECTROMAGNETIC FIELD TEST SETUP .....	39
7.7	PHOTOGRAPH – SURGE IMMUNITY TEST SETUP .....	40
7.8	PHOTOGRAPH – INJECTED CURRENTS IMMUNITY TEST SETUP .....	40
7.9	PHOTOGRAPH – VOLTAGE DIPS AND INTERRUPTIONS IMMUNITY TEST SETUP .....	41
<b>8</b>	<b>PHOTOGRAPHS – CONSTRUCTIONAL DETAILS</b> .....	<b>42</b>
8.1	EUT .....	42



# WALTEK



### 3 General Information

#### 3.1 General Description of E.U.T.

**Product Name** ..... : Li-ion Battery Charger

**Model No.** ..... : SSLC076V42BD

**Remark**..... : None

#### 3.2 Details of E.U.T.

**Technical Data**..... : Input:100-240V,50-60Hz,80W,Output:42V,1.8A

#### 3.3 Description of Support Units

The EUT has been tested as an independent unit. SSLC076V42BD is the test sample. The all tests were performed in the condition of AC230V/50Hz input.

#### 3.4 Standards Applicable for Testing

The tests were performed according to following standards:

EN55014-1: 2011	Electromagnetic compatibility-Requirements for household appliances, electric tools and similar apparatus-Part 1:Emission
EN55014-2:1997+A1:2001 +A2:2008	Electromagnetic compatibility Requirements for household appliances, Part 2: Immunity Product family.
EN 61000-3-2:2014	Electromagnetic compatibility (EMC) -- Part 3-2: Limits - Limits for harmonic current emissions (equipment input current up to and including 16 A per phase).
EN 61000-3-3:2013	Electromagnetic compatibility (EMC) -- Part 3-3: Limits - Limitation of voltage changes, voltage fluctuations and flicker in public low-voltage supply systems, for equipment with rated current $\leq 16$ A per phase and not subject to conditional connection.





### 3.5 Test Facility

The test facility has a test site registered with the following organizations:

- **IC – Registration No.: 7760A**

Waltek Services (Shenzhen) Co., Ltd. has been registered and fully described in a report filed with the Industry Canada. The acceptance letter from the Industry Canada is maintained in our files. Registration 7760A, July 12, 2010.

- **FCC – Registration No.: 880581**

Waltek Services (Shenzhen) Co., Ltd. has been registered and fully described in a report filed with the (FCC) Federal Communications Commission. The acceptance letter from the FCC is maintained in our files. Registration 880581, May 26, 2011.

### 3.6 Subcontracted

Whether parts of tests for the product have been subcontracted to other labs:

Yes       No

If Yes, list the related test items and lab information:

Test items:RS

Lab information: QuieTek Technology(Suzhou) Co.,Ltd.

CNAS:L5313

### 3.7 Abnormalities from Standard Conditions

None.



# WALTEK



#### 4 Equipment Used during Test

<input checked="" type="checkbox"/> Mains Terminal Disturbance Voltage (Conducted Emission)					
Item	Equipment	Manufacturer	Model No.	Serial No.	Calibration Data
1.	Test Receiver	ROHDE & SCHWARZ	ESCI	101297	2015.4.13
2.	Two-Line V-Network	ROHDE & SCHWARZ	ENV216	101538	2015.4.13
3.	Manual RF SW	ESE	RSU-A41	-	N/A
4.	3m,50 ohms Cable	HUBER SUHNER	1016873	-	N/A
<input checked="" type="checkbox"/> Disturbance Power					
Item	Equipment	Manufacturer	Model No.	Serial No.	Calibration Data
1.	Test Receiver	ROHDE & SCHWARZ	ESCI	101297	2015.4.13
2.	Absorbing Clamp	Luethi	MDS21	4204	2015.4.13
3.	Attenuator	JFW	50FP-006-H3	-	N/A
4.	Manual RF SW	ESE	RSU-A41	-	N/A
5.	9m,50 ohms Cable	HUBER SUHNER	1016873	-	N/A
<input checked="" type="checkbox"/> Discontinuous Disturbance					
Item	Equipment	Manufacturer	Model No.	Serial No.	Calibration Data
1.	Discontinues Disturbance Analyzer	TESEQ	DIA1512D	28302	2015.4.13
2.	LISN	R&S	ENV216	101215	2015.4.13
<input checked="" type="checkbox"/> Harmonics and Flicker Measuring System					
Item	Equipment	Manufacturer	Model No.	Serial No.	Calibration Data
1.	Digital Power Analyzer	Em Test AG	ADP500	V0745103095	2015.4.13
2.	Power Source	Em Test AG	ACS500	V0745103096	2015.4.13
<input checked="" type="checkbox"/> ESD					
Item	Equipment	Manufacturer	Model No.	Serial No.	Calibration Data
1.	Electrostatic Discharge Simulator	TESEQ	NSG 438	1235	2015.4.14
<input checked="" type="checkbox"/> EFT & Voltage Dips and Interruptions					
Item	Equipment	Manufacturer	Model No.	Serial No.	Calibration Data
1.	EFT Simulator	TESEQ	NSG 3040	1982	2015.4.13
2.	Capacitive Coupling Clamp	TESEQ	CDN 3425	1690	2015.4.13
3.	Manual step transformer	TESEQ	INA6501	226	2015.4.13
<input checked="" type="checkbox"/> Surge					
Item	Equipment	Manufacturer	Model No.	Serial No.	Calibration Data



1.	Surge Simulator	TESEQ	NSG3060	1516	2015.4.13
2.	Coupling Decoupling Network	TESEQ	CDN3061-S16	1434	2015.4.13
<input checked="" type="checkbox"/> <b>Injected Currents</b>					
Item	Equipment	Manufacturer	Model No.	Serial No.	Calibration Data
1.	RF generator	TESEQ	NSG4070	35088	2015.4.13
2.	Power Amplifier	TESEQ	CBA 400M-110	T44225	2015.4.13
3.	EM Clamp	TESEQ	KEMZ801A	33477	2015.4.13
4.	Coupling Decoupling Network	TESEQ	CDN M016	34615	2015.4.13
5.	Dual Directional Coupler	TESEQ	DCP 0100A	34574	2015.4.13
<input checked="" type="checkbox"/> <b>Radio-frequency electromagnetic fields</b>					
Item	Equipment	Manufacturer	Model No.	Serial No.	Calibration Data
1.	Signal Generator	R&S	SML03	102324	2015.10.09
2.	Power Meter	Agilent	E4416A	GB412938 44	2015.09.16
3.	Power Sensor	Agilent	E9323A	MY444203 02	2015.09.16
4.	Power Meter	Boonton	4231A	144502	2015.09.16
5.	Power Sensor	Boonton	51011-EMC	33859	2015.09.16
6.	RF Switch	MF	SW1072	RFSW9800 05	N/A
7.	Power Amplifier	Schaffner	CBA9428	43516	N/A
8.	Power Amplifier	Schaffner	CBA9413B	43526	N/A
9.	Directional Coupler	AR	DC7144A	312249	N/A
10.	Directional Coupler	Schaffner	CHA 9652B	121	N/A
11.	Horn Antenna	AR	AT4002A	312312	N/A
12.	Bilog Antenna	Schaffner	CBL6141A	4278	N/A





#### 4.1 Measurement Uncertainty

Test Item	Frequency Range	Uncertainty	Note
Conducted Emission	150kHz~30MHz	$\pm 2.66\text{dB}$	(1)
Disturbance Power	30MHz~300MHz	$\pm 3.21\text{dB}$	(1)
Radiated Emission	30MHz~1GHz	$\pm 5.03\text{dB}$	(1)

(1) This uncertainty represents an expanded uncertainty expressed at approximately the 95% confidence level using a coverage factor of  $k=2$ .



# WALTEK



## 5 Emission Test Results

### 5.1 Mains Terminals Disturbance Voltage, 148.5kHz to 30MHz

Test Requirement.....	: EN 55014-1
Test Method.....	: EN 55014-1
Test Result.....	: Pass
Frequency Range.....	: 148.5kHz to 30MHz
Class/Severity.....	: Table 1 of EN55014-1

#### 5.1.1 E.U.T. Operation

##### Operating Environment:

Temperature.....	: 24°C
Humidity.....	: 55%RH
Atmospheric Pressure.....	: 100.3kPa

##### EUT Operation:

Input Voltage.....	: AC230V/50Hz
Operating Mode.....	: Full load mode

#### 5.1.2 Block Diagram of Test Setup

The Mains Terminals Disturbance Voltage tests were performed in accordance with the EN 55014-1.

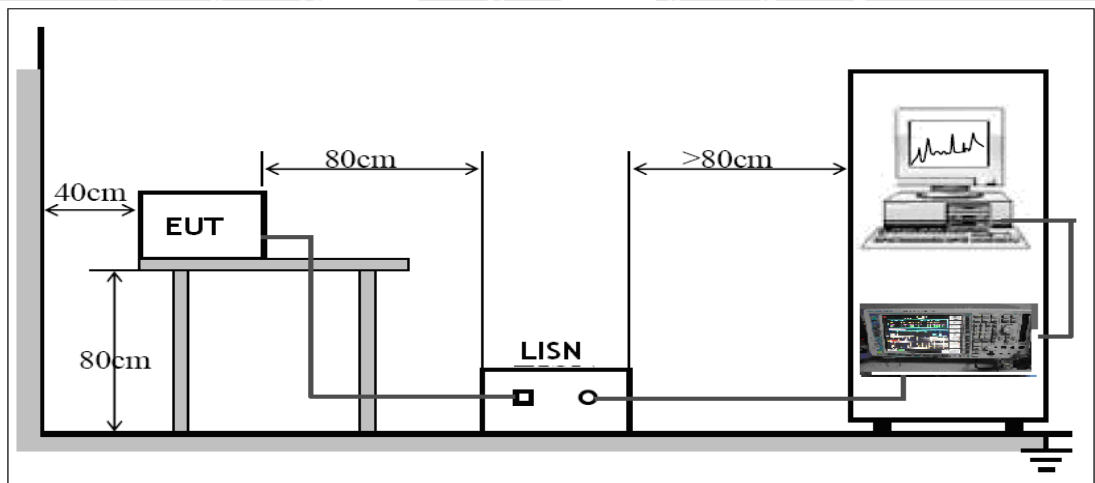



### 5.1.3 Measurement Data

The maximised peak emissions from the EUT was scanned and measured for both the Live and Neutral Lines. Quasi-peak & average measurements were performed if peak emissions were within 6dB of the average limit line.

### 5.1.4 Mains Terminals Disturbance Voltage Test Data

Live Line :

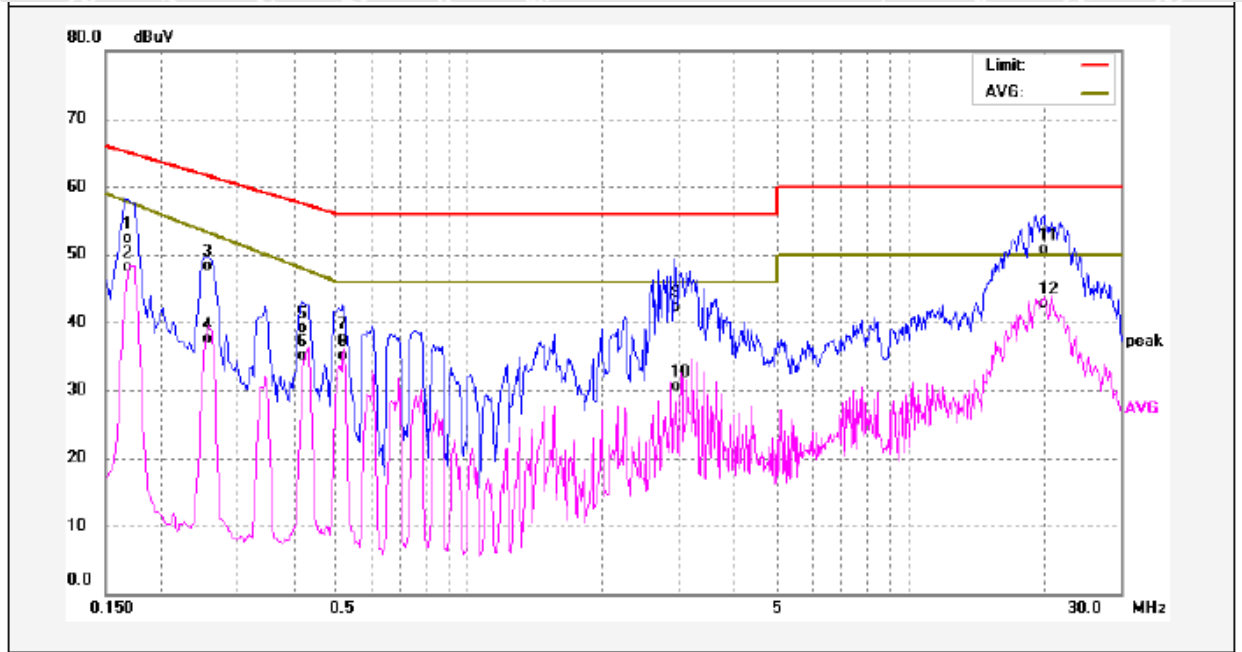

No.	Freq. (MHz)	Reading (dBuV)	Factor (dB)	Result (dBuV)	Limit dBuV	Margin (dB)	Detector	Remark
1	0.1712	42.75	9.61	52.36	64.90	-12.54	QP	
2	0.1712	38.41	9.61	48.02	57.57	-9.55	AVG	
3	0.2560	38.65	9.60	48.25	61.56	-13.31	QP	
4	0.2560	27.84	9.60	37.44	53.22	-15.78	AVG	
5	0.4179	29.51	9.59	39.10	57.49	-18.39	QP	
6	0.4179	25.59	9.59	35.18	47.94	-12.76	AVG	
7	0.5180	28.07	9.58	37.65	56.00	-18.35	QP	
8	0.5180	25.53	9.58	35.11	46.00	-10.89	AVG	
9	2.9219	32.73	9.62	42.35	56.00	-13.65	QP	
10	2.9219	20.85	9.62	30.47	46.00	-15.53	AVG	
11	20.0780	40.75	10.03	50.78	60.00	-9.22	QP	
12	20.0780	32.63	10.03	42.66	50.00	-7.34	AVG	





**Neutral Line :**

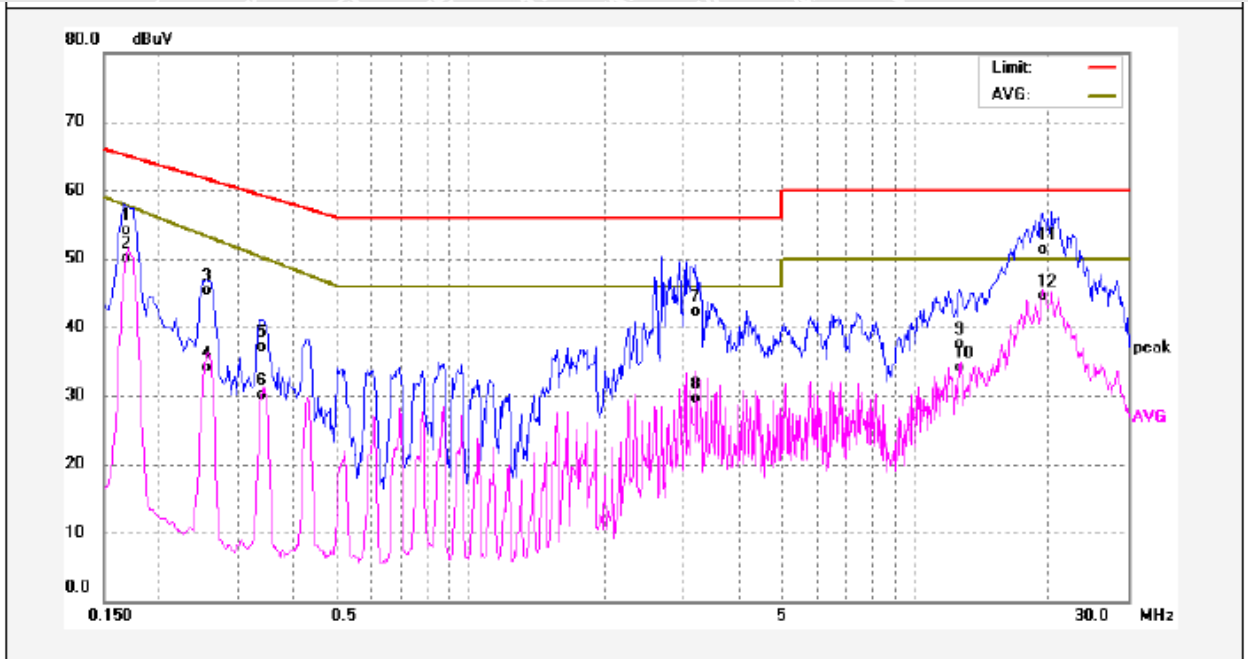

No.	Freq. (MHz)	Reading (dBuV)	Factor (dB)	Result (dBuV)	Limit dBuV	Margin (dB)	Detector	Remark
1	0.1700	44.41	9.61	54.02	64.96	-10.94	QP	
2	0.1700	40.51	9.61	50.12	57.64	-7.52	AVG	
3	0.2540	35.63	9.60	45.23	61.62	-16.39	QP	
4	0.2540	24.52	9.60	34.12	53.31	-19.19	AVG	
5	0.3379	27.53	9.59	37.12	59.25	-22.13	QP	
6	0.3379	20.43	9.59	30.02	50.23	-20.21	AVG	
7	3.2180	32.60	9.63	42.23	56.00	-13.77	QP	
8	3.2180	19.93	9.63	29.56	46.00	-16.44	AVG	
9	12.5219	27.66	9.83	37.49	60.00	-22.51	QP	
10	12.5219	24.32	9.83	34.15	50.00	-15.85	AVG	
11	19.3060	41.25	10.01	51.26	60.00	-8.74	QP	
12	19.3060	34.47	10.01	44.48	50.00	-5.52	AVG	



## 5.2 Disturbance Power, 30MHz to 300MHz

**Test Requirement**..... : EN 55014-1  
**Test Method**..... : EN 55014-1  
**Test Result**..... : Pass  
**Frequency Range**..... : 30MHz to 300MHz  
**Class/Severity**..... : Table 2 of EN55014-1

### 5.2.1 E.U.T. Operation

#### Operating Environment:

**Temperature** ..... : 24°C  
**Humidity**..... : 55%RH  
**Barometric Pressure**..... : 100.3kPa

#### EUT Operation:

**Input Voltage** ..... : AC230V/50Hz  
**Operating Mode**..... : Full load mode

### 5.2.2 Block Diagram of Test Setup

The Disturbance Power test was performed in accordance with the EN 55014-1.

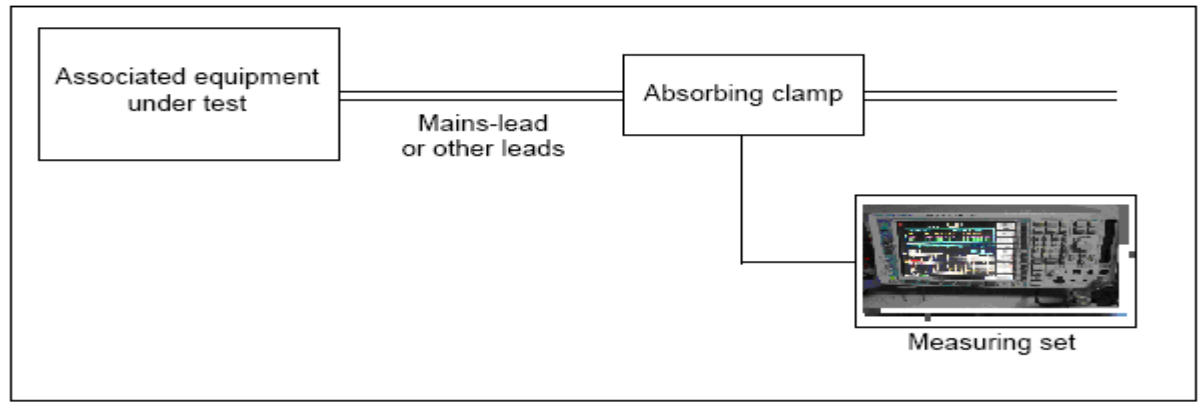



### 5.2.3 Measurement Data

Extending the cable to 6 meters, performed quasi-peak & average measurements since peak emissions from the EUT were detected within 15dB of the limit line. Average measurements were only performed if the quasi-peak measurements were within 15dB of the average limit line.

According to the Clause 4.1.2.3, if both of the following conditions (1) and (2) are fulfilled: 1) all emission readings from the equipment under test shall be lower than the applicable limits (Table 2a) reduced by the margin (Table 2b); 2) the maximum clock frequency shall be less than 30 MHz. The Appliances are deemed to comply in the frequency range from 300 MHz to 1 000 MHz

### 5.2.4 Disturbance Power Test Results on AC Line

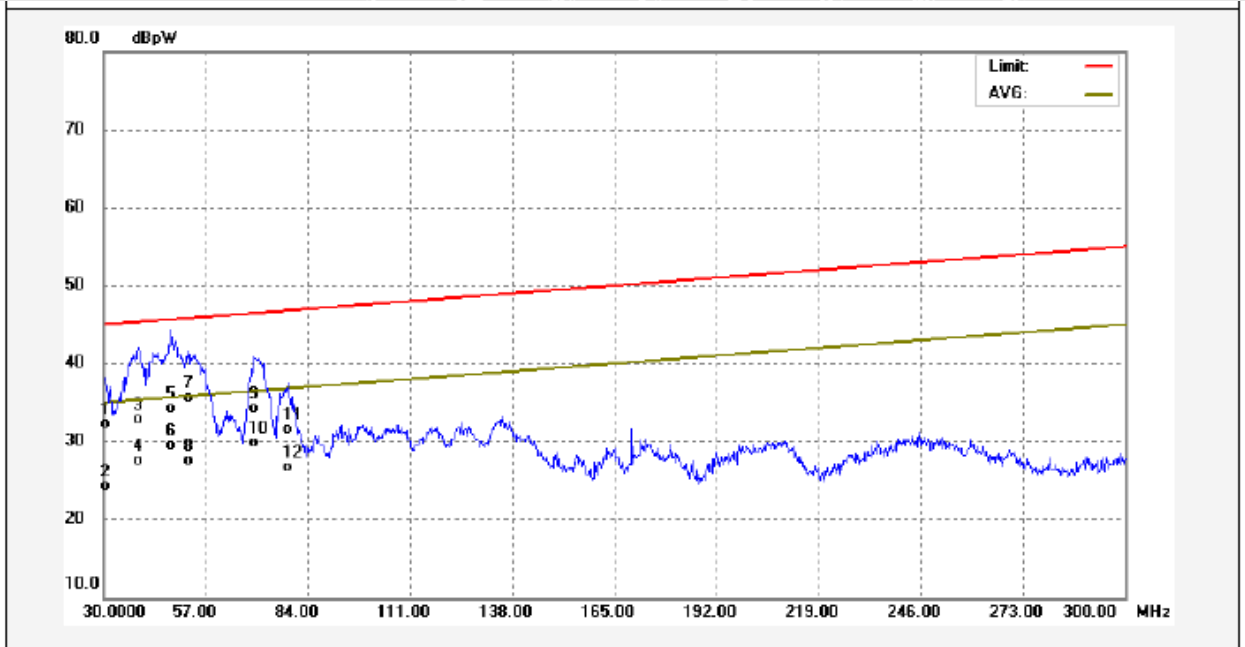

No.	Freq. (MHz)	Reading (dBpW)	Factor (dB)	Result (dBpW)	Limit (dBpW)	Margin (dB)	Detector	Remark
1	30.5397	6.34	25.92	32.26	45.02	-12.76	QP	
2	30.5397	-1.66	25.92	24.26	35.02	-10.76	AVG	
3	39.1800	7.53	25.23	32.76	45.34	-12.58	QP	
4	39.1800	2.39	25.23	27.62	35.34	-7.72	AVG	
5	47.8200	10.96	23.22	34.18	45.66	-11.48	QP	
6	47.8200	6.37	23.22	29.59	35.66	-6.07	AVG	
7	52.4099	12.01	23.58	35.59	45.83	-10.24	QP	
8	52.4099	4.01	23.58	27.59	35.83	-8.24	AVG	
9	69.6898	10.34	23.82	34.16	46.47	-12.31	QP	
10	69.6898	6.06	23.82	29.88	36.47	-6.59	AVG	
11	78.8700	7.61	23.98	31.59	46.81	-15.22	QP	
12	78.8700	2.76	23.98	26.74	36.81	-10.07	AVG	





### 5.3 Harmonics Current Emission

**Test Requirement**..... : EN61000-3-2  
**Test Method**..... : EN61000-3-2  
**Test Result**..... : Pass  
**Class/Severity**..... : Class A

#### 5.3.1 E.U.T. Operation

**Operating Environment:**

**Temperature** ..... : 24°C  
**Humidity**..... : 60%RH  
**Barometric Pressure**..... : 100.3kPa

**EUT Operation:**

**Input Voltage** ..... : AC230V/50Hz  
**Operating Mode**..... : Full load mode

#### 5.3.2 Block Diagram of Setup

The Harmonics Current emission test was performed in accordance with the EN 61000-3-2.

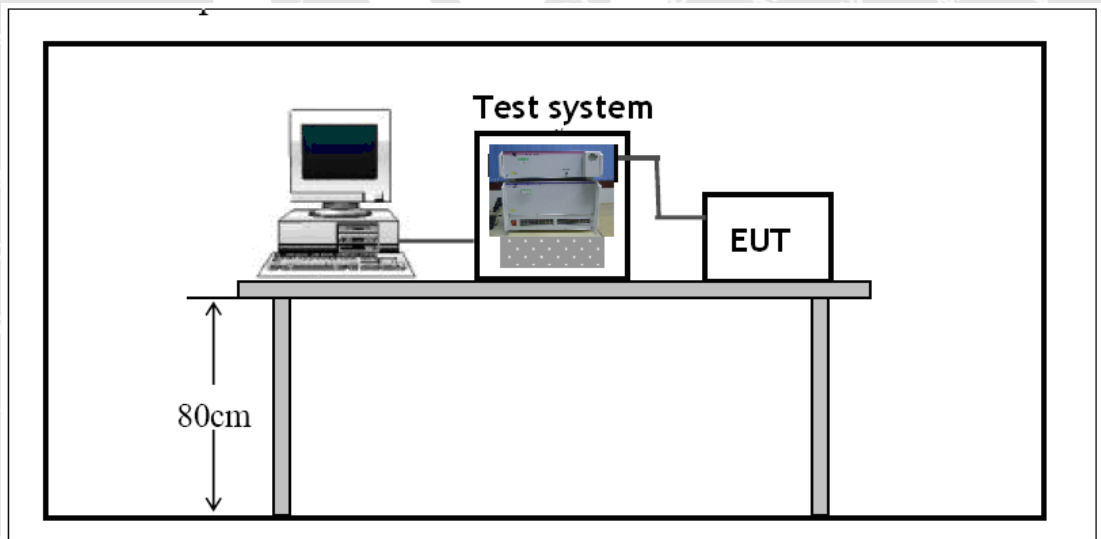



### 5.3.3 Harmonic Current Emission Test Data

Report title:	WTU15U0933879E
Company Name:	
Date of test:	9:48 21.Sep 2015
Measurement file name:	WTU15U0933879E_H.rsd
Tester:	Lobei Zhu
Standard used:	EN/IEC 61000-3-2 Ed.3 Short cyclic Equipment class A <= 150% of the limit
Observation time:	150s
Windows width:	10 periods - (EN/IEC 61000-4-7 Edition 2002)
E. U. T.:	

#### **Power and THD results - DS: 1**

True power P:	75W	Apparent power S:	155.4VA
Reactiv power Q:	136.1var	Power factor:	0.483
THD (U):	0.001	THD (I):	1.696
Crest Factor (U):	1.415	Crest Factor (I):	3.728

#### **Check harmonics 2..40 [exception odd 21..39]:**

<b>Harmonic(s) &gt; 150%:</b>	
Order (n):	None
<b>Harmonic(s) with average &gt; 100%:</b>	
Order (n):	None

#### **Check odd harmonics 21..39:**

<b>All Partial Odd Harmonics below partial limits.</b>	
<b>Harmonic(s) &gt; 150%:</b>	
Order (n):	None
<b>Harmonic(s) with average &gt; 150%:</b>	
Order (n):	None



<b>Average harmonic current results</b>				
Hn	I <sub>eff</sub> [A]	I <sub>eff</sub> [%]	Limit [A]	Result
1	352.003E-3	100.000		
2	1.062E-3	0.302	1.08	PASS
3	324.331E-3	92.139	2.30	PASS
4	2.252E-3	0.640	430.00E-3	PASS
5	296.464E-3	84.222	1.14	PASS
6	928.905E-6	0.264	300.00E-3	PASS
7	259.420E-3	73.698	770.00E-3	PASS
8	960.858E-6	0.273	230.00E-3	PASS
9	214.638E-3	60.976	400.00E-3	PASS
10	860.086E-6	0.244	184.00E-3	PASS
11	168.755E-3	47.941	330.00E-3	PASS
12	930.573E-6	0.264	153.33E-3	PASS
13	124.818E-3	35.459	210.00E-3	PASS
14	1.044E-3	0.297	131.43E-3	PASS
15	88.325E-3	25.092	150.00E-3	PASS
16	843.210E-6	0.240	115.00E-3	PASS
17	63.162E-3	17.944	132.35E-3	PASS
18	1.029E-3	0.292	102.22E-3	PASS
19	51.686E-3	14.683	118.42E-3	PASS
20	855.321E-6	0.243	92.00E-3	PASS
21	49.458E-3	14.050	160.71E-3	PASS
22	756.234E-6	0.215	83.64E-3	PASS
23	48.760E-3	13.852	146.74E-3	PASS
24	724.329E-6	0.206	76.66E-3	PASS
25	44.219E-3	12.562	135.00E-3	PASS
26	807.007E-6	0.229	70.77E-3	PASS
27	37.341E-3	10.608	124.99E-3	PASS
28	744.362E-6	0.211	65.71E-3	PASS
29	29.113E-3	8.271	116.39E-3	PASS
30	753.216E-6	0.214	61.33E-3	PASS
31	22.388E-3	6.360	108.87E-3	PASS
32	846.766E-6	0.241	57.50E-3	PASS
33	18.385E-3	5.223	102.27E-3	PASS
34	669.427E-6	0.190	54.12E-3	PASS
35	17.516E-3	4.976	96.44E-3	PASS
36	803.805E-6	0.228	51.11E-3	PASS
37	17.269E-3	4.906	91.21E-3	PASS
38	648.765E-6	0.184	48.42E-3	PASS
39	16.436E-3	4.669	86.53E-3	PASS
40	656.686E-6	0.187	46.00E-3	PASS





### Maximum harmonic current results

Hn	I <sub>eff</sub> [A]	I <sub>eff</sub> [%]	Limit [A]	Result
1	357.312E-3	100.000		
2	1.217E-3	0.341	1.62	PASS
3	328.842E-3	92.032	3.45	PASS
4	2.485E-3	0.696	645.00E-3	PASS
5	300.507E-3	84.102	1.71	PASS
6	1.020E-3	0.286	450.00E-3	PASS
7	263.688E-3	73.798	1.15	PASS
8	1.096E-3	0.307	345.00E-3	PASS
9	219.313E-3	61.379	600.00E-3	PASS
10	1.006E-3	0.282	276.00E-3	PASS
11	173.270E-3	48.493	495.00E-3	PASS
12	1.031E-3	0.289	229.99E-3	PASS
13	129.243E-3	36.171	315.00E-3	PASS
14	1.162E-3	0.325	197.15E-3	PASS
15	92.633E-3	25.925	225.00E-3	PASS
16	946.130E-6	0.265	172.50E-3	PASS
17	67.255E-3	18.822	198.52E-3	PASS
18	1.152E-3	0.323	153.33E-3	PASS
19	55.242E-3	15.460	177.63E-3	PASS
20	951.867E-6	0.266	138.00E-3	PASS
21	52.468E-3	14.684	160.71E-3	PASS
22	964.164E-6	0.270	125.46E-3	PASS
23	51.458E-3	14.401	146.74E-3	PASS
24	843.635E-6	0.236	114.99E-3	PASS
25	46.897E-3	13.125	135.00E-3	PASS
26	924.713E-6	0.259	106.16E-3	PASS
27	40.119E-3	11.228	124.99E-3	PASS
28	873.923E-6	0.245	98.57E-3	PASS
29	31.632E-3	8.853	116.39E-3	PASS
30	835.366E-6	0.234	92.00E-3	PASS
31	24.427E-3	6.836	108.87E-3	PASS
32	927.661E-6	0.260	86.25E-3	PASS
33	19.792E-3	5.539	102.27E-3	PASS
34	757.469E-6	0.212	81.18E-3	PASS
35	18.473E-3	5.170	96.44E-3	PASS
36	910.534E-6	0.255	76.66E-3	PASS
37	18.129E-3	5.074	91.21E-3	PASS
38	722.873E-6	0.202	72.63E-3	PASS
39	17.341E-3	4.853	86.53E-3	PASS
40	821.680E-6	0.230	69.00E-3	PASS



### Maximum harmonic voltage results

Hn	Ueff [V]	Ueff [%]	Limit [%]	Result
1	230.76	100.331		
2	77.74E-3	0.034	0.2	PASS
3	126.55E-3	0.055	0.9	PASS
4	11.84E-3	0.005	0.2	PASS
5	67.55E-3	0.029	0.4	PASS
6	9.78E-3	0.004	0.2	PASS
7	77.56E-3	0.034	0.3	PASS
8	8.17E-3	0.004	0.2	PASS
9	53.54E-3	0.023	0.2	PASS
10	17.51E-3	0.008	0.2	PASS
11	108.81E-3	0.047	0.1	PASS
12	16.65E-3	0.007	0.1	PASS
13	66.07E-3	0.029	0.1	PASS
14	14.42E-3	0.006	0.1	PASS
15	91.89E-3	0.040	0.1	PASS
16	12.35E-3	0.005	0.1	PASS
17	51.70E-3	0.022	0.1	PASS
18	11.46E-3	0.005	0.1	PASS
19	40.11E-3	0.017	0.1	PASS
20	12.00E-3	0.005	0.1	PASS
21	67.49E-3	0.029	0.1	PASS
22	11.34E-3	0.005	0.1	PASS
23	81.30E-3	0.035	0.1	PASS
24	13.84E-3	0.006	0.1	PASS
25	30.38E-3	0.013	0.1	PASS
26	11.77E-3	0.005	0.1	PASS
27	37.61E-3	0.016	0.1	PASS
28	15.20E-3	0.007	0.1	PASS
29	64.36E-3	0.028	0.1	PASS
30	13.69E-3	0.006	0.1	PASS
31	42.99E-3	0.019	0.1	PASS
32	8.88E-3	0.004	0.1	PASS
33	44.95E-3	0.020	0.1	PASS
34	9.52E-3	0.004	0.1	PASS
35	45.41E-3	0.020	0.1	PASS
36	10.22E-3	0.004	0.1	PASS
37	43.45E-3	0.019	0.1	PASS
38	8.18E-3	0.004	0.1	PASS
39	21.59E-3	0.009	0.1	PASS
40	7.00E-3	0.003	0.1	PASS



### Harmonic current results - DS: 1

Hn	I <sub>eff</sub> [A]	I <sub>eff</sub> [%]	Limit [A]	Result
1	340.580E-3	100.000		
2	1.004E-3	0.295	1.08	PASS
3	313.778E-3	92.131	2.30	PASS
4	2.258E-3	0.663	430.00E-3	PASS
5	286.149E-3	84.018	1.14	PASS
6	887.273E-6	0.261	300.00E-3	PASS
7	249.030E-3	73.120	770.00E-3	PASS
8	969.574E-6	0.285	230.00E-3	PASS
9	204.437E-3	60.026	400.00E-3	PASS
10	794.812E-6	0.233	184.00E-3	PASS
11	159.186E-3	46.740	330.00E-3	PASS
12	865.063E-6	0.254	153.33E-3	PASS
13	115.677E-3	33.965	210.00E-3	PASS
14	969.486E-6	0.285	131.43E-3	PASS
15	79.407E-3	23.315	150.00E-3	PASS
16	810.711E-6	0.238	115.00E-3	PASS
17	54.995E-3	16.147	132.35E-3	PASS
18	0.999E-3	0.293	102.22E-3	PASS
19	44.577E-3	13.089	118.42E-3	PASS
20	805.508E-6	0.237	92.00E-3	PASS
21	43.520E-3	12.778	107.14E-3	PASS
22	801.425E-6	0.235	83.64E-3	PASS
23	43.412E-3	12.747	97.83E-3	PASS
24	724.290E-6	0.213	76.66E-3	PASS
25	39.122E-3	11.487	90.00E-3	PASS
26	743.549E-6	0.218	70.77E-3	PASS
27	32.208E-3	9.457	83.33E-3	PASS
28	739.123E-6	0.217	65.71E-3	PASS
29	24.348E-3	7.149	77.59E-3	PASS
30	696.664E-6	0.205	61.33E-3	PASS
31	18.452E-3	5.418	72.58E-3	PASS
32	837.531E-6	0.246	57.50E-3	PASS
33	15.677E-3	4.603	68.18E-3	PASS
34	662.303E-6	0.194	54.12E-3	PASS
35	15.717E-3	4.615	64.29E-3	PASS
36	790.227E-6	0.232	51.11E-3	PASS
37	15.746E-3	4.623	60.81E-3	PASS
38	677.566E-6	0.199	48.42E-3	PASS
39	14.738E-3	4.327	57.69E-3	PASS
40	642.423E-6	0.189	46.00E-3	PASS





### Harmonic voltage results - DS: 1

Hn	Ueff [V]	Ueff [%]	Limit [%]	Result
1	230.75	100.328		
2	70.21E-3	0.031	0.2	PASS
3	111.04E-3	0.048	0.9	PASS
4	8.61E-3	0.004	0.2	PASS
5	56.15E-3	0.024	0.4	PASS
6	3.79E-3	0.002	0.2	PASS
7	68.80E-3	0.030	0.3	PASS
8	1.22E-3	0.001	0.2	PASS
9	47.44E-3	0.021	0.2	PASS
10	11.41E-3	0.005	0.2	PASS
11	93.45E-3	0.041	0.1	PASS
12	12.59E-3	0.005	0.1	PASS
13	48.38E-3	0.021	0.1	PASS
14	4.56E-3	0.002	0.1	PASS
15	66.02E-3	0.029	0.1	PASS
16	2.86E-3	0.001	0.1	PASS
17	43.72E-3	0.019	0.1	PASS
18	7.20E-3	0.003	0.1	PASS
19	22.95E-3	0.010	0.1	PASS
20	5.42E-3	0.002	0.1	PASS
21	59.55E-3	0.026	0.1	PASS
22	4.95E-3	0.002	0.1	PASS
23	65.70E-3	0.029	0.1	PASS
24	5.84E-3	0.003	0.1	PASS
25	22.32E-3	0.010	0.1	PASS
26	6.11E-3	0.003	0.1	PASS
27	29.78E-3	0.013	0.1	PASS
28	7.73E-3	0.003	0.1	PASS
29	51.08E-3	0.022	0.1	PASS
30	7.89E-3	0.003	0.1	PASS
31	32.54E-3	0.014	0.1	PASS
32	3.53E-3	0.002	0.1	PASS
33	31.43E-3	0.014	0.1	PASS
34	5.06E-3	0.002	0.1	PASS
35	36.95E-3	0.016	0.1	PASS
36	6.93E-3	0.003	0.1	PASS
37	33.14E-3	0.014	0.1	PASS
38	1.92E-3	0.001	0.1	PASS
39	13.42E-3	0.006	0.1	PASS
40	894.07E-6	0.000	0.1	PASS

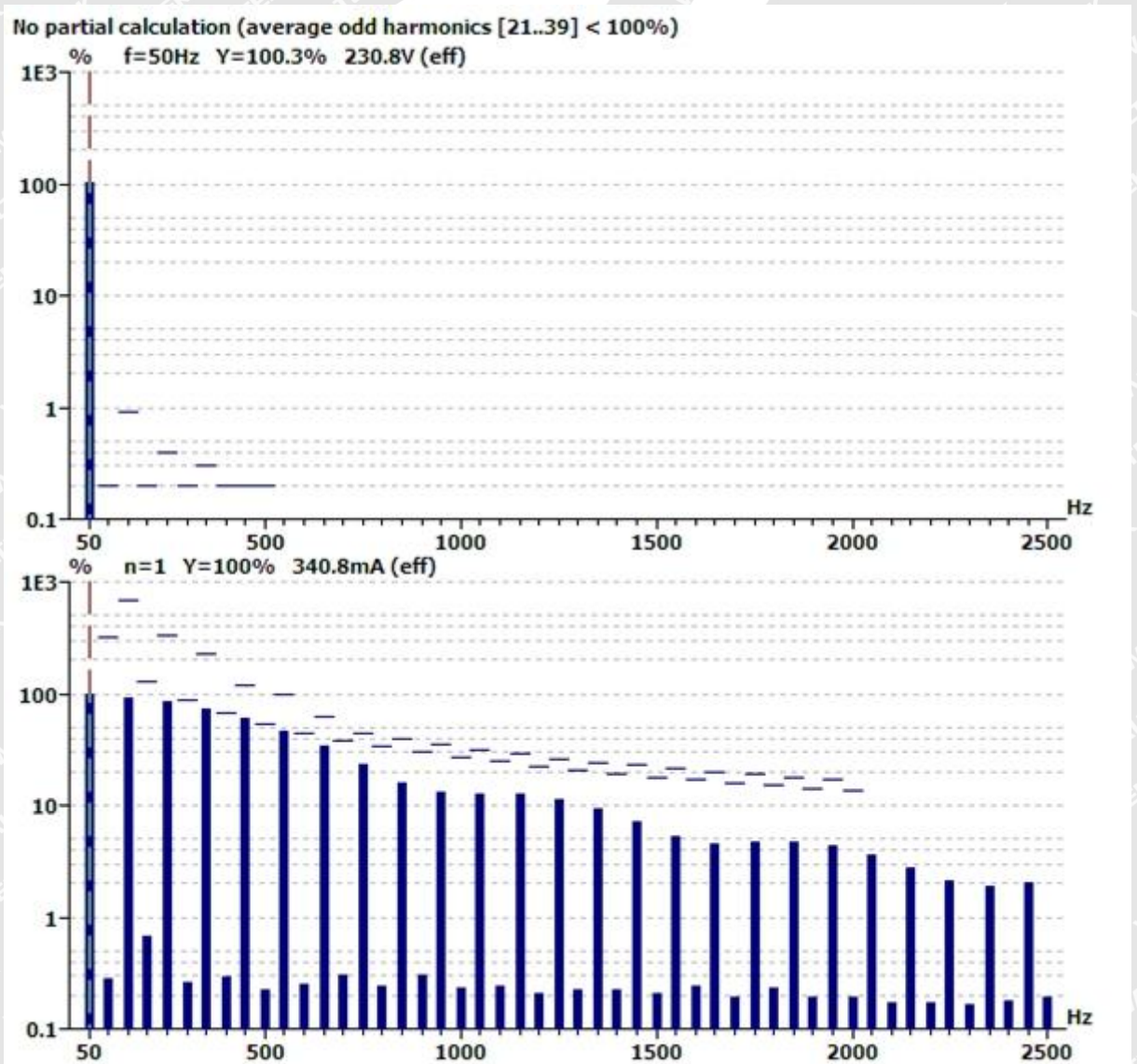
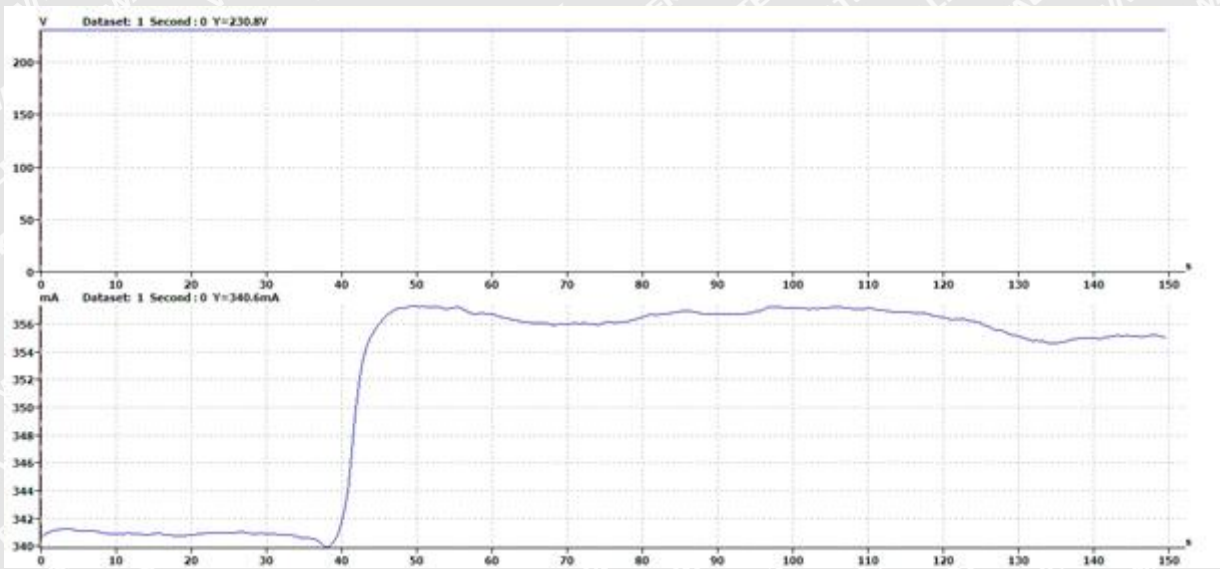

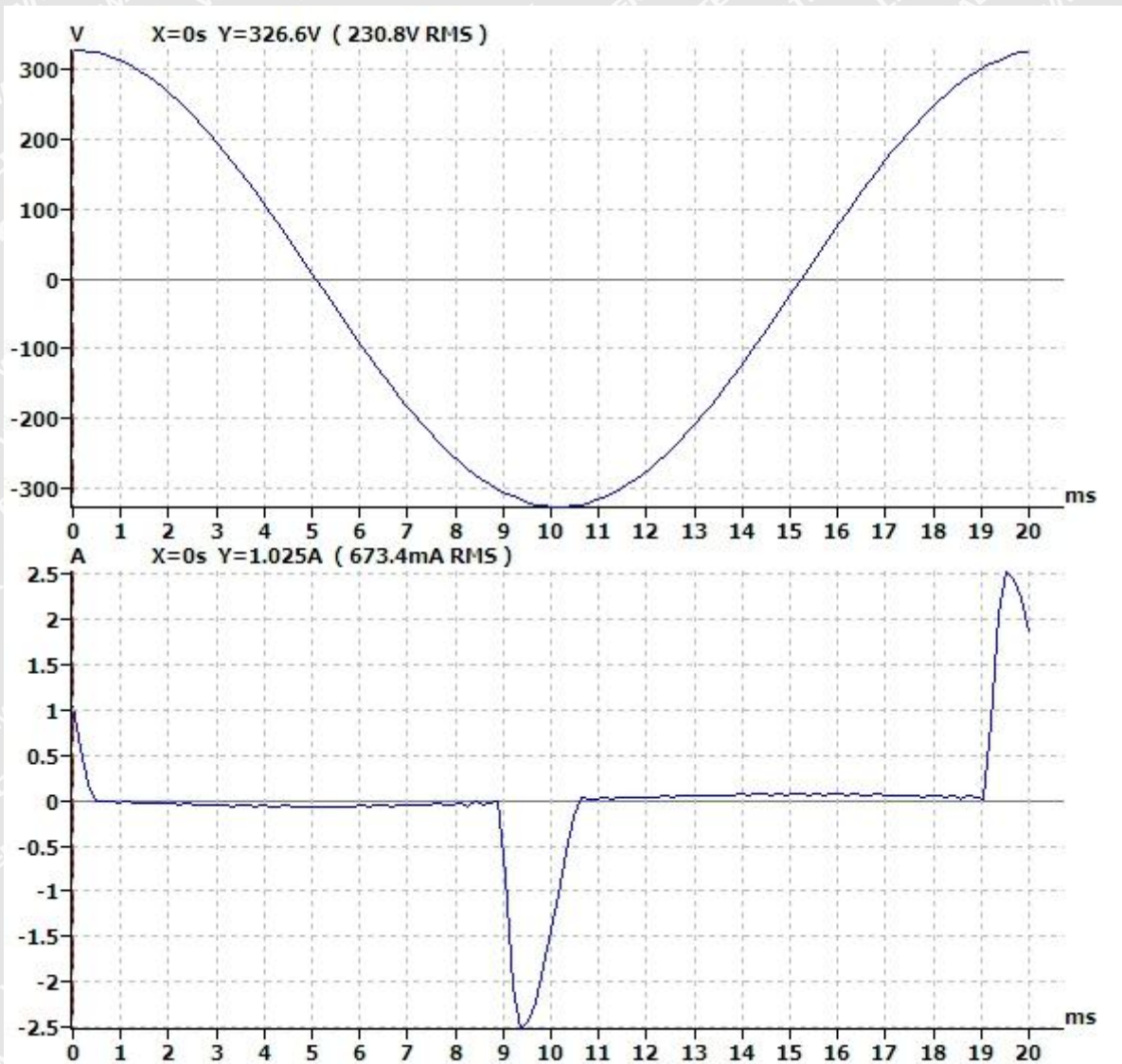

**WALTEK**





### 5.4 Voltage Fluctuation and Flicker

Test Requirement ..... : EN 61000-3-3  
Test Method ..... : EN 61000-3-3  
Test Result ..... : Pass

#### 5.4.1 E.U.T. Operation

**Operating Environment:**

Temperature ..... : 24°C

Humidity..... : 60%RH

Barometric Pressure..... : 100.3kPa

**EUT Operation:**

Input Voltage ..... : AC230V/50Hz

Operating Mode..... : Full load mode

#### 5.4.2 Block Diagram of Setup

The Voltage Fluctuation and Flicker test was performed in accordance with the EN 61000-3-3.

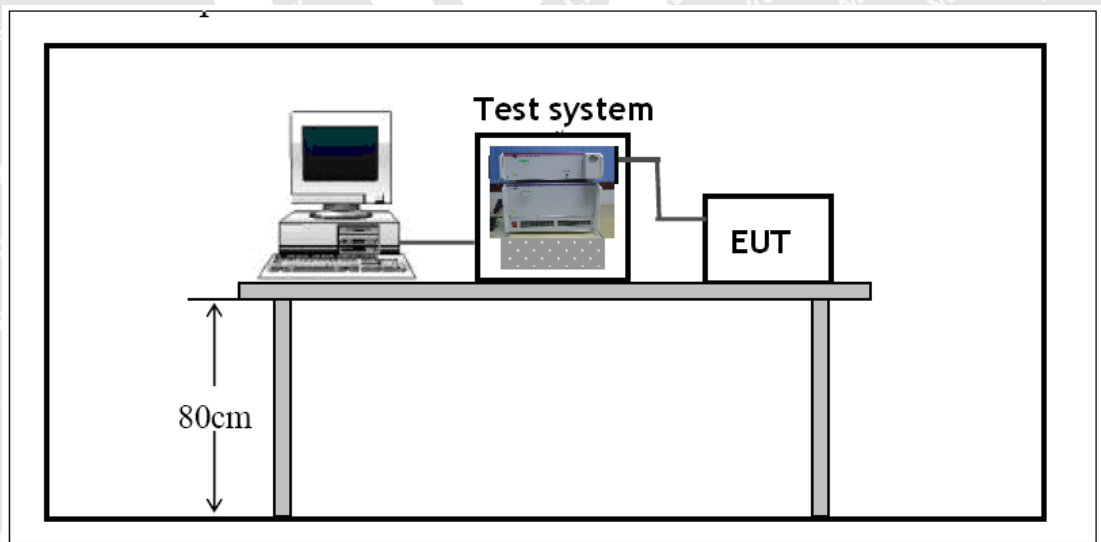



### 5.4.3 Voltage Fluctuation and Flicker Test Data

Report title:	WTU15U0933879E
Company Name:	
Date of test:	9:35 21.Sep 2015
Tester:	Lobei Zhu
Standard used:	EN/IEC 61000-3-3 Flicker
Short time (Pst):	10 min
Observation time:	10 min (1 Flicker measurement)
Flickermeter:	230V / 50Hz
Flicker Impedance:	Zref (IEC 60725)
Customer:	
E. U. T.:	

	<b>EUT values</b>	<b>Limit</b>	<b>Result</b>
Pst	0.035	1.00	PASS
Plt	0.035	0.65	PASS
dc [%]	0.054	3.30	PASS
dmax [%]	0.265	4.00	PASS
dt [s]	0.000	0.50	PASS

# WALTEK



## 6 Immunity Test Results

### 6.1 Performance Criteria

**Performance criterion A:** The apparatus shall continue to operate as intended during the test. No degradation of performance or loss of function is allowed below a performance level (or permissible loss of performance) specified by the manufacturer, when the apparatus is used as intended. If the minimum performance level or the permissible performance loss is not specified by the manufacturer, then either of these may be derived from the product description and documentation, and from what the user may reasonably expect from the apparatus if used as intended.

**Performance criterion B:** The apparatus shall continue to operate as intended after the test. No degradation of performance or loss of function is allowed below a performance level (or permissible loss of performance) specified by the manufacturer, when the apparatus is used as intended. During the test, degradation of performance is allowed, however, no change of actual operating state or stored data is allowed. If the minimum performance level or the permissible performance loss is not specified by the manufacturer, then either of these may be derived from the product description and documentation, and from what the user may reasonably expect from the apparatus if used as intended.

**Performance criterion C:** Temporary loss of function is allowed, provided the function is self-recoverable or can be restored by the operation of the controls, or by any operation specified in the instructions for use. For further details, please refer to EN 55014-2.

### 6.2 Electrostatic Discharge (ESD)

<b>Test Requirement</b> .....	:	EN 55014-2
<b>Test Method</b> .....	:	IEC 61000-4-2
<b>Test Result</b> .....	:	Pass
<b>Discharge Impedance</b> .....	:	330Ω / 150pF
<b>Discharge Voltage</b> .....	:	Air Discharge: ±8kV Contact Discharge: ±4kV HCP & VCP: ±4kV
<b>Polarity</b> .....	:	Positive & Negative
<b>Number of Discharge</b> .....	:	Minimum 10 times at each test point
<b>Discharge Mode</b> .....	:	Single Discharge
<b>Discharge Period</b> .....	:	1 second minimum





### 6.2.1 E.U.T. Operation

#### Operating Environment:

- Temperature ..... : 24°C
- Humidity ..... : 48%RH
- Barometric Pressure ..... : 100.3kPa

#### EUT Operation:

- Input Voltage ..... : AC230V/50Hz
- Operating Mode ..... : Full load mode

### 6.2.2 Block Diagram of Setup

The ESD test was performed in accordance with the IEC 61000-4-2.

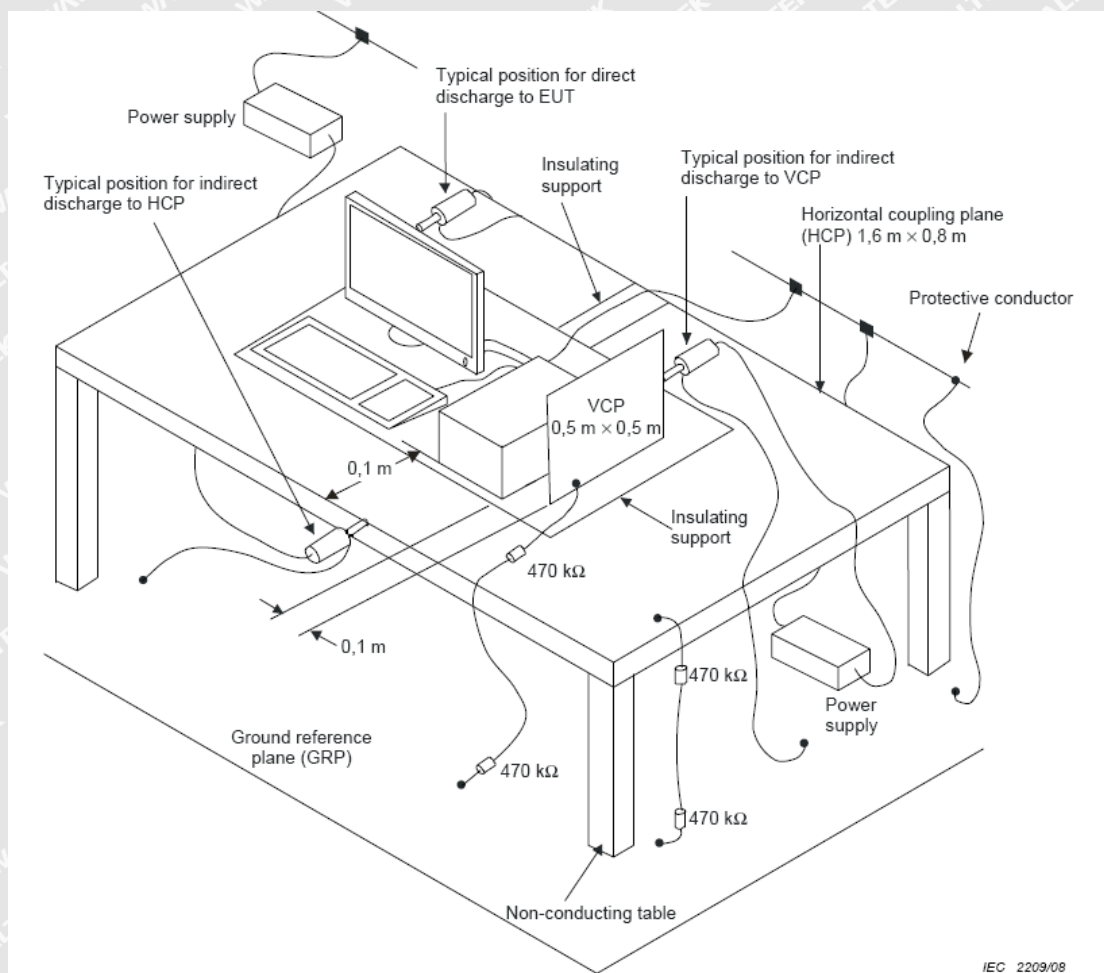





### 6.3.1E.U.T. Operation

#### Operating Environment:

Temperature .....	: 24°C
Humidity .....	: 60%RH
Barometric Pressure .....	: 100.3kPa

#### EUT Operation:

Input Voltage .....	: AC230V/50Hz
Operating Mode .....	: Full load mode

### 6.3.2 Block Diagram of Setup

The Electrical Fast Transients Immunity test was performed in accordance with the IEC 61000-4-4.

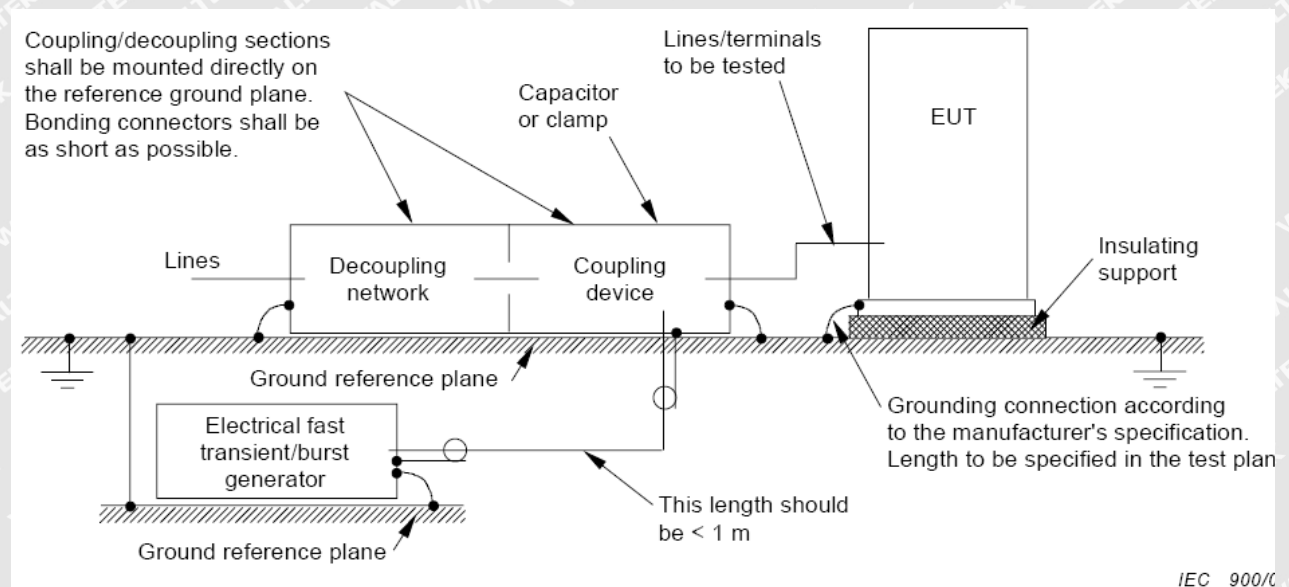

### 6.3.3 Test Results

Test Port	Test Level(kV)	Performance Criterion	Result
Line-Neutral-PE	±1.0	B	Pass*

Remark:

\* During the test no deviation was detected to the selected operation mode(s)





### 6.4 Surge

- Test Requirement..... : EN 55014-2
- Test Method..... : IEC 61000-4-5
- Test Result..... : Pass
- Test level..... : ±1kV Live to Neutral, ±2kV Live to PE and Neutral to PE,
- Interval ..... : 60s between each surge
- No. of surges ..... : 5 positive at 90°, 5 negative at 270°.

### 6.4.1 E.U.T. Operation

#### Operating Environment:

- Temperature ..... : 24°C
- Humidity..... : 60%RH
- Barometric Pressure..... : 100.3kPa

#### EUT Operation:

- Input Voltage ..... : AC230V/50Hz
- Operating Mode..... : Full load mode

### 6.4.2 Block Diagram of Setup

The Surge Immunity test was performed in accordance with the IEC 61000-4-5.

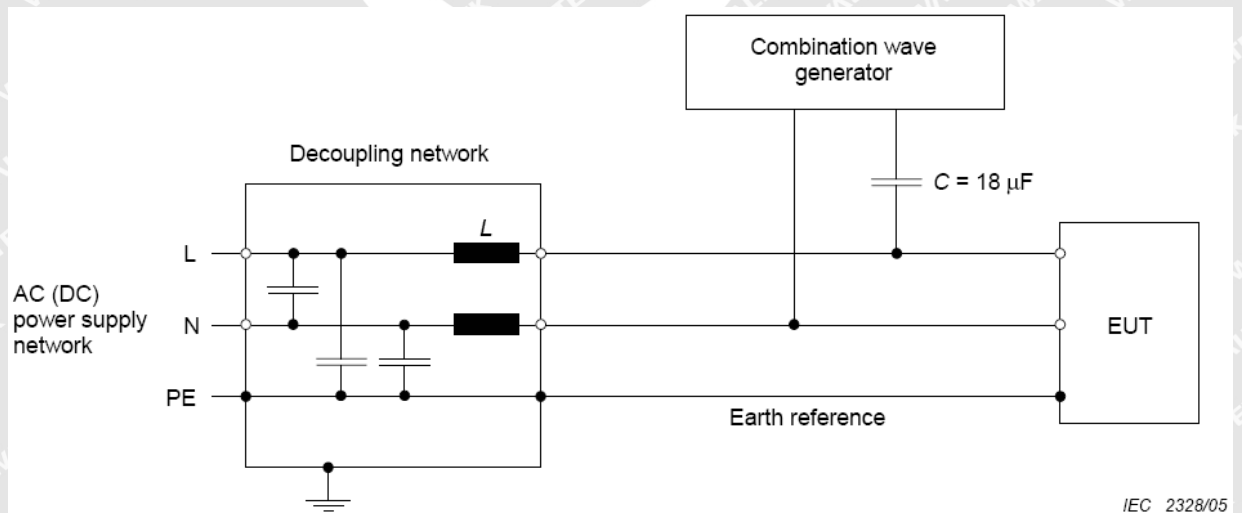



### 6.4.3 Test Results

Test Port	Applied Voltage (kV)	Performance criterion	Result
Between Live And Neutral:	$\pm 1$	B	Pass*
Between Live And Earth:	$\pm 2$	B	Pass*
Between Neutral And Earth:	$\pm 2$	B	Pass*

Remark:

- \* During the test no deviation was detected to the selected operation mode(s)

### 6.5 Radio-frequency electromagnetic fields, 80MHz to 1GHz

Test Requirement .....	: EN 55014
Test Method .....	: IEC 61000-4-3
Test Result .....	: Pass
Frequency Range .....	: 80MHz to 1GHz
Test level .....	: 3V/m
Modulation .....	: 80%, 1kHz Amplitude Modulation.
Face of EUT .....	: Front, Back, Left, Right
Antenna polarisation ..	: Horizontal& Vertical

#### 6.5.1 E.U.T. Operation

Operating Environment:

Temperature.....	: 23°C
Humidity.....	: 65%RH
Barometric Pressure .....	: 100.3kPa

EUT Operation:

Input Voltage.....	: AC 230V/50Hz
Operating Mode.....	: Full load mode



### 6.5.2 Block Diagram of Setup

The Radio-frequency electromagnetic fields Immunity test was performed in accordance with the IEC 61000-4-3.

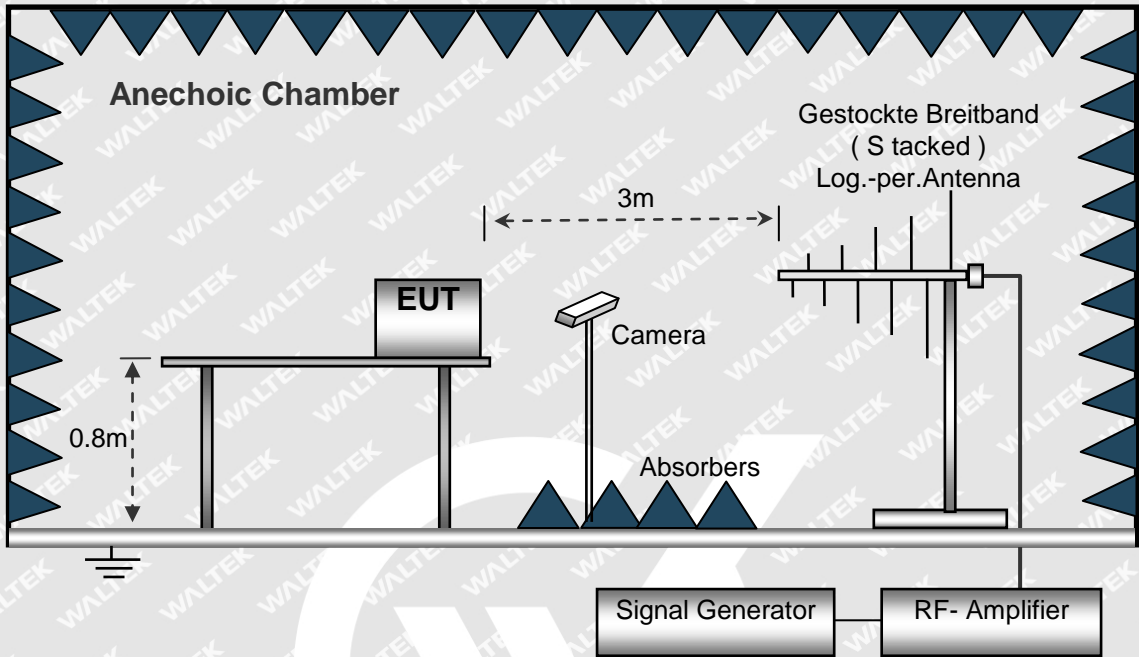

### 6.5.3 Test Results

Frequency	Face of EUT	Antenna polarisation	Test Level	Step Size	Dwell Time	Performance Criterion	Result
80 to 1000MHz	Front, Back, Left, Right	Horizontal	3V/m	1%	2s	A	Pass*
80 to 1000MHz	Front, Back, Left, Right	Vertical	3V/m	1%	2s	A	Pass*

Remark:

- \* During the test no deviation was detected to the selected operation mode(s)





### 6.6 Injected Currents Immunity, 0.15MHz to 230MHz

- Test Requirement** ..... : EN 55014-2
- Test Method** ..... : IEC 61000-4-6
- Test Result** ..... : Pass
- Frequency Range** ..... : 0.15MHz to 230MHz
- Test level** ..... : 3V r.m.s. (unmodulated emf into 150 Ω)
- Modulation** ..... : 80%, 1kHz Amplitude Modulation.

#### 6.6.1 E.U.T. Operation

##### Operating Environment:

- Temperature** ..... : 24°C
- Humidity** ..... : 60%RH
- Barometric Pressure** ..... : 100.3kPa

##### EUT Operation:

- Input Voltage** ..... : AC230V/50Hz
- Operating Mode** ..... : Full load mode

#### 6.6.2 Block Diagram of Setup

The Injected Currents Immunity test was performed in accordance with the IEC 61000-4-6.

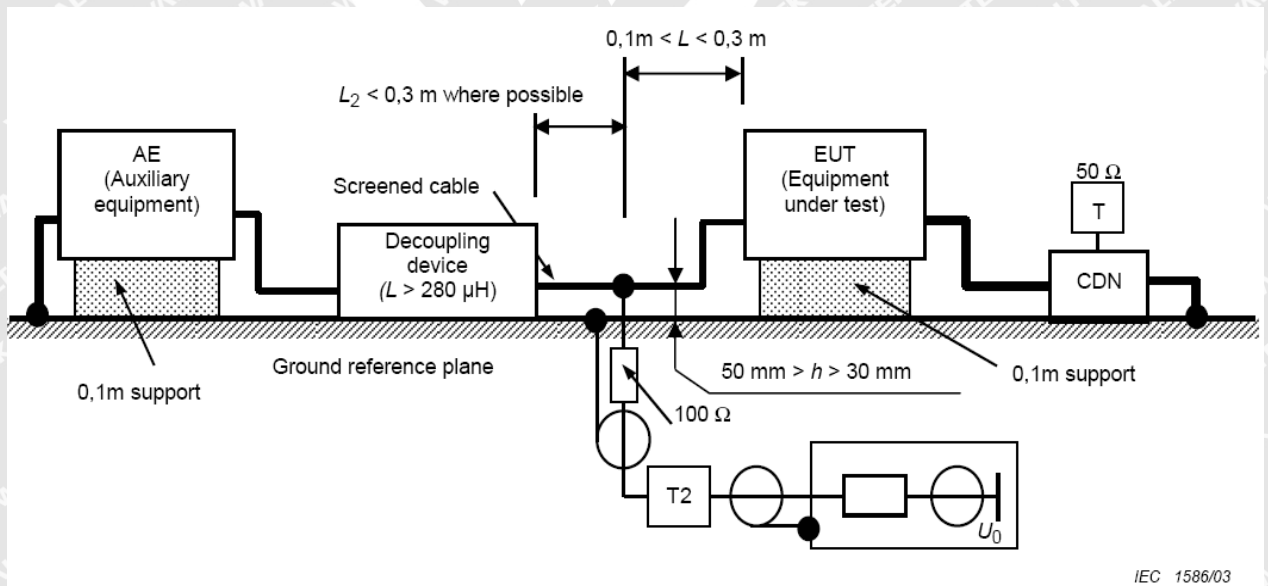



### 6.6.3 Test Results

Frequency	Line	Test Level	Modulation	Step Size	Dwell Time	Performance Criterion	Result
0.15MHz to 230MHz	3 Wire AC Supply Cables	3Vr.m.s.	80%, 1kHz Amp. Mod.	1%	1s	A	Pass*

Remark:

\* During the test no deviation was detected to the selected operation mode(s)



# WALTEK



### 6.7 Voltage Dips and Interruptions

Test Requirement.....	EN 55014-2
Test Method.....	IEC 61000-4-11
Test Result.....	Pass
Test Level(Voltage reduction)	0% & 40% &70 % of $U_T$ (Supply Voltage)
No. of Dips / Interruptions.....	1 per Level at 20ms intervals

#### 6.7.1 E.U.T. Operation

**Operating Environment:**

Temperature .....	24°C
Humidity.....	60%RH
Barometric Pressure.....	100.3kPa

**EUT Operation:**

Input Voltage .....	AC230V/50Hz
Operating Mode.....	Full load mode

#### 6.7.2 Block Diagram of Setup

The Voltage Dips and Interruptions Immunity test was performed in accordance with the IEC 61000-4-11.

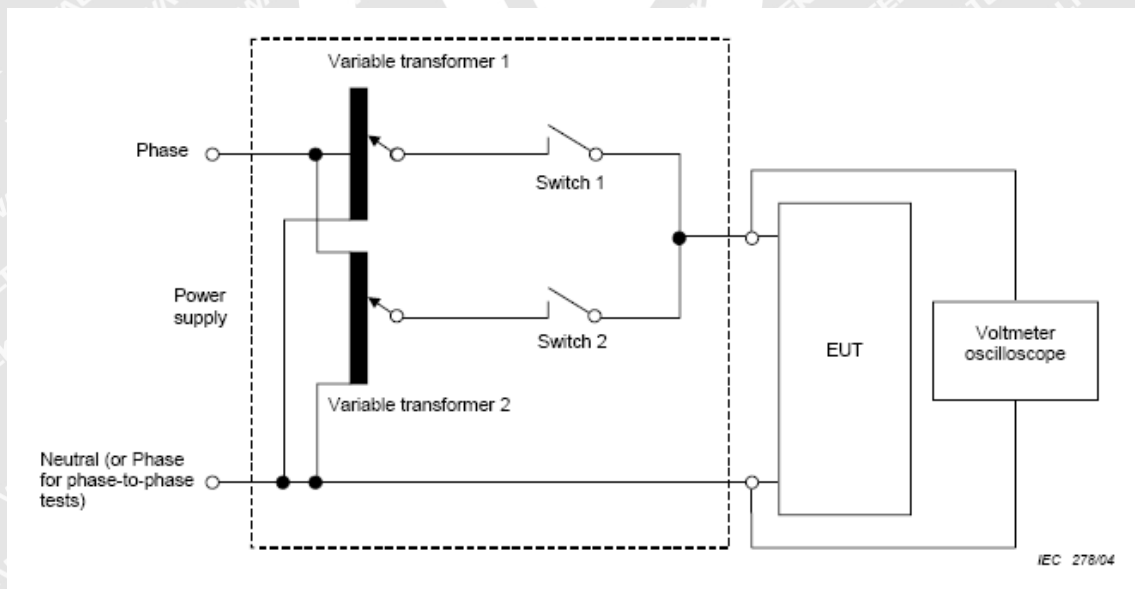





### 6.7.3 Test Results

Test Level in %U <sub>T</sub>	Performance criterion	50Hz		60Hz	
		Duration	Result	Duration	Result
0	C	0.5	Pass*	0.5	N/A
40	C	10	Pass*	12	N/A
70	C	25	Pass*	30	N/A

Remark:

\* During the test no deviation was detected to the selected operation mode(s)



# WALTEK



## 7 Photographs – Test Setup

### 7.1 Photograph – Mains Terminal Disturbance Voltage Test Setup



### 7.2 Photograph – Disturbance Power Test Setup







### 7.3 Photograph – Harmonic Current and Voltage Fluctuation and Flicker Test Setup



### 7.4 Photograph – ESD Immunity Test Setup

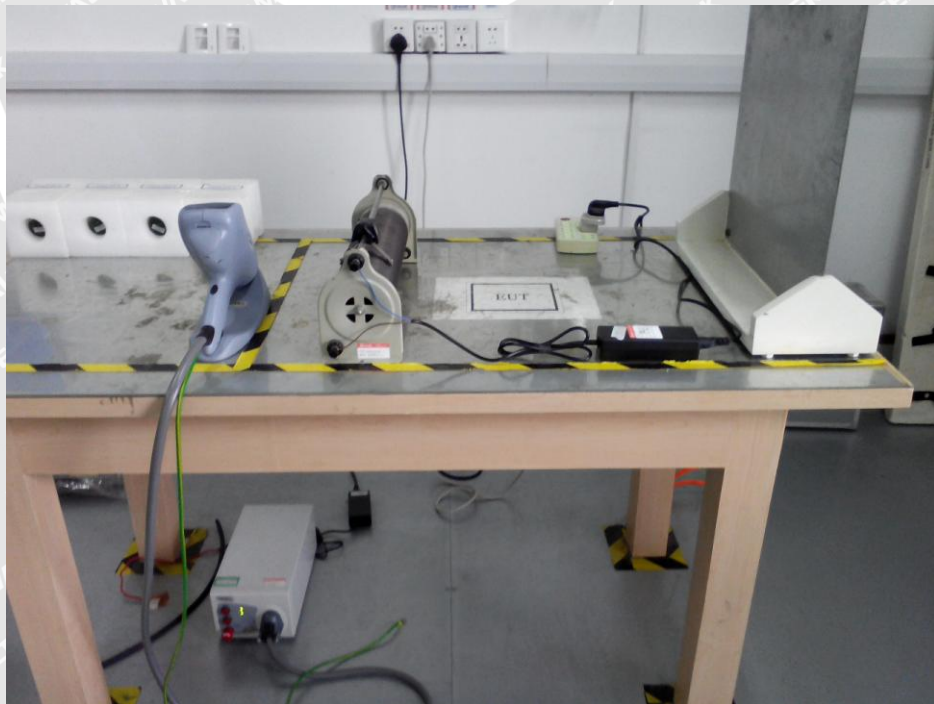





### 7.5 Photograph – EFT Immunity Test Setup

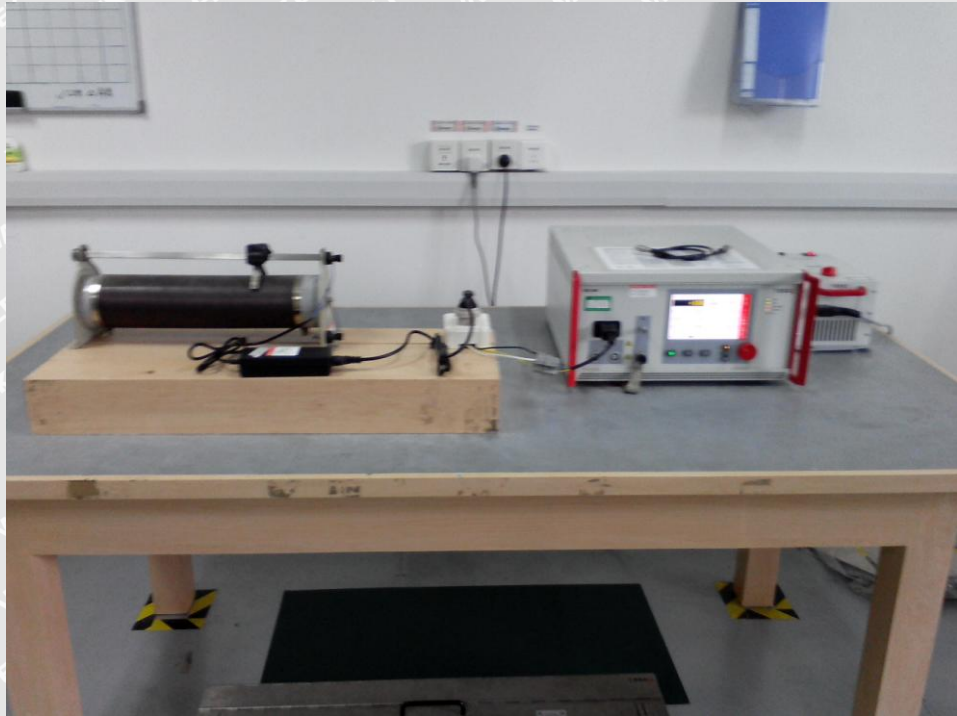

### 7.6 Photograph – Radio-Frequency Electromagnetic Field Test Setup





### 7.7 Photograph – Surge Immunity Test Setup



### 7.8 Photograph – Injected Currents Immunity Test Setup

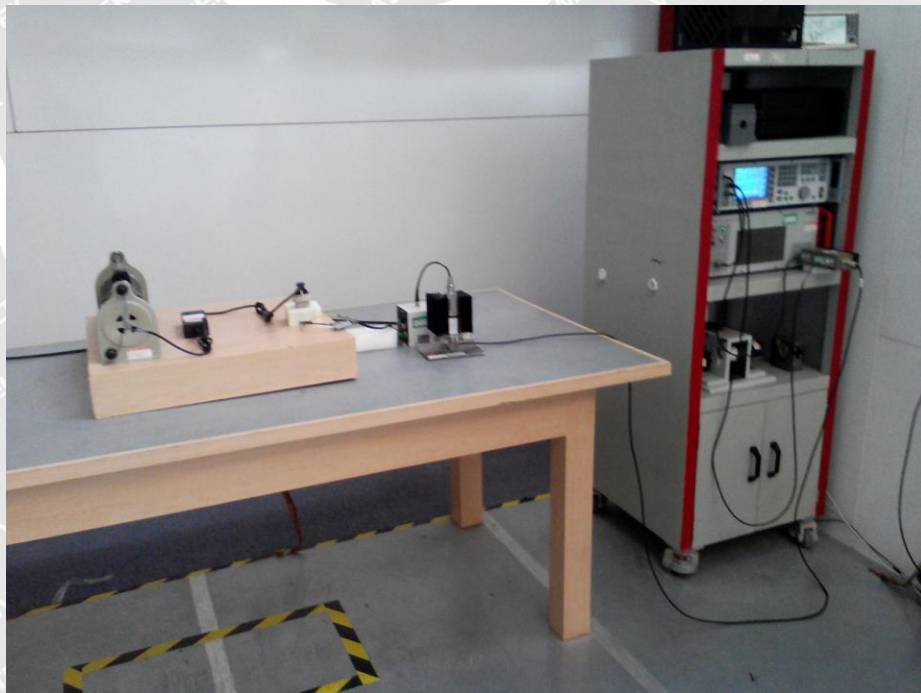





## 7.9 Photograph – Voltage Dips and Interruptions Immunity Test Setup

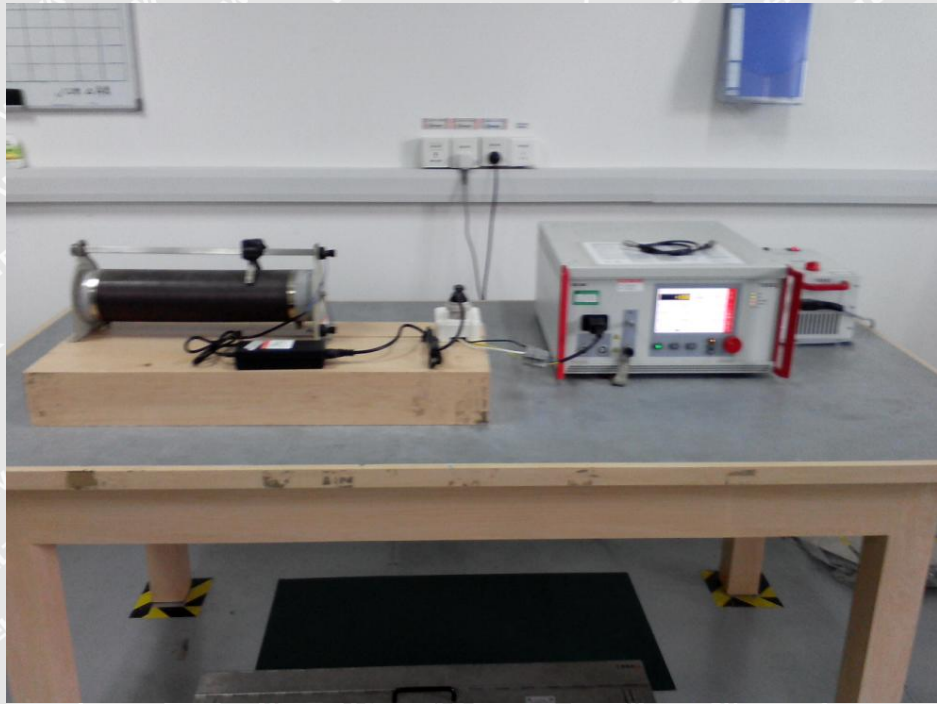





## 8 Photographs – Constructional Details

### 8.1 EUT













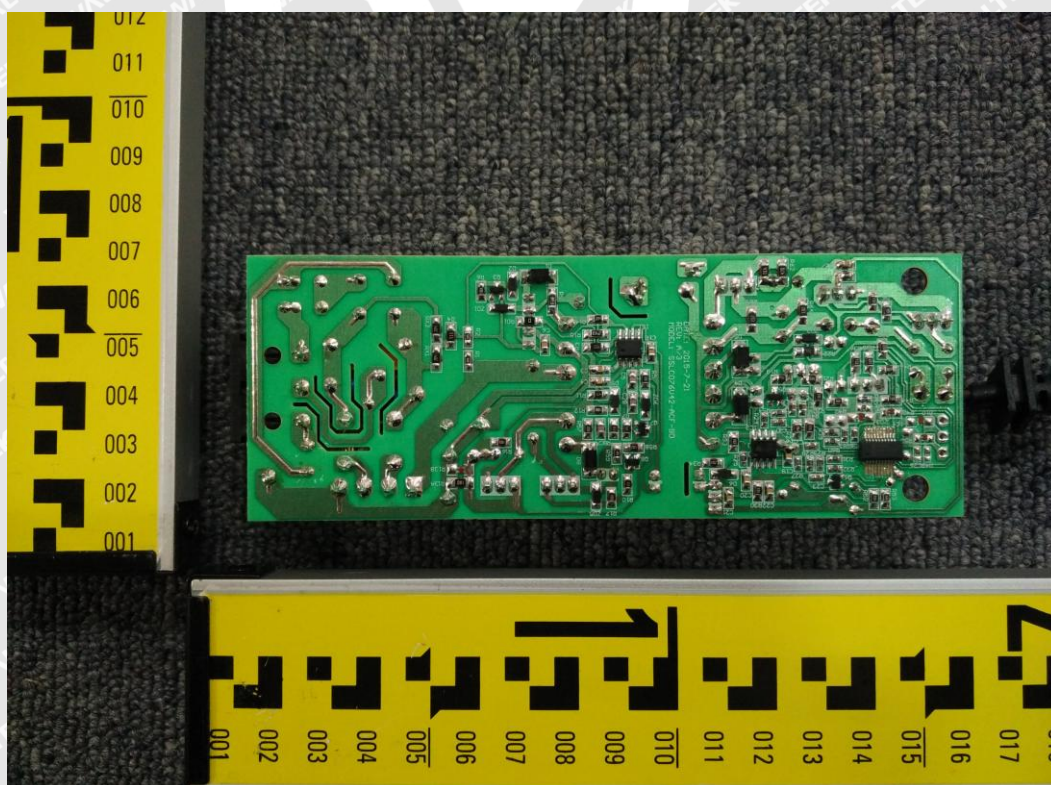
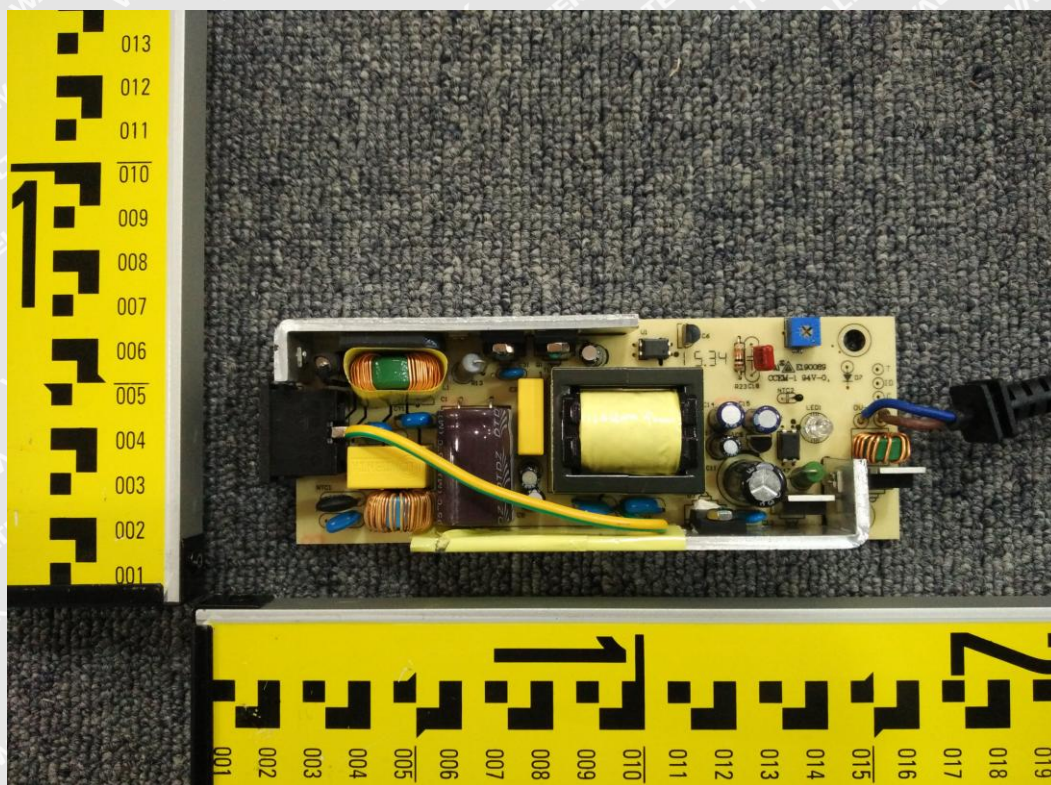

====End of Report====